

Type EI28/12

Power 1.0VA

Weight 70g

shipping unit per box: 40 PCS

temperature class: ta 70°C/B

Safety transformer/Short circuit proof

**Vacuum filled casting**

Split bobbin design winding

**Dielectric strength 4500Vrms**

PART NO	Output ta 70°C/B	Prim.V	Connecting pins	Operating point sec. ± 10%	Connecting pins	No-load voltage V ± 10%
TG2812-U2-0100-090-D	1.0 W	115	1--2	9V 55.5mA	6--7	12.0V
		115	4--5	9V 55.5mA	9--10	12.0V

According to

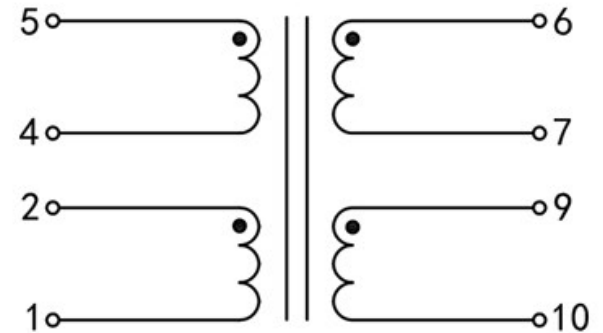
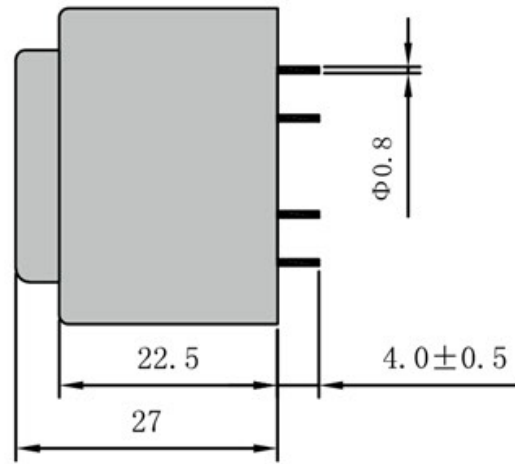
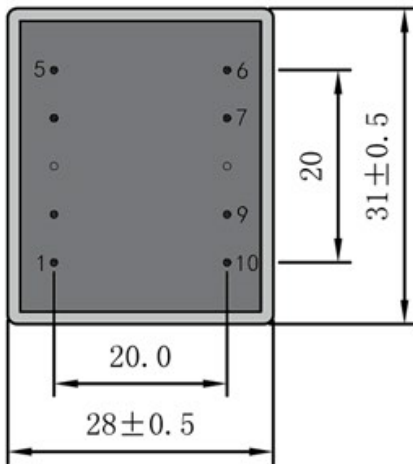

Dimensions with no indication of tolerances: ± 0.3mm  
Custom-made transformer also will be welcome.

