

Type EI28/12

Power 1.5VA

Weight 70g

shipping unit per box: 40 PCS

temperature class: ta 50°C/B

Safety transformer/Short circuit proof

Vacuum filled casting

Split bobbin design winding

Dielectric strength 4500Vrms

PART NO	Output ta 70°C/B	Prim.V	Connecting pins	Operating point sec. ± 10%	Connecting pins	No-load voltage V ± 10%
TG2812-U2-0150-090-D	1.5 W	115	1--2	9V 83.3mA	6--7	12.5V
		115	4--5	9V 83.3mA	9--10	12.5V

According to

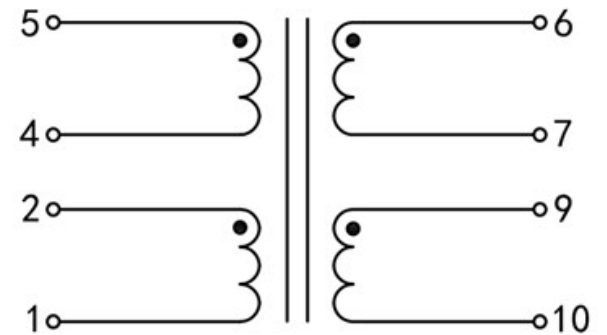
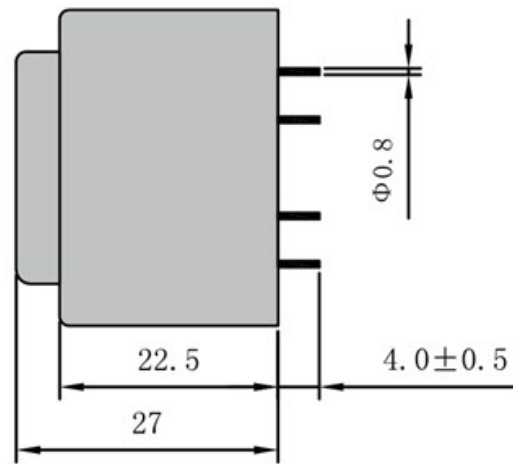
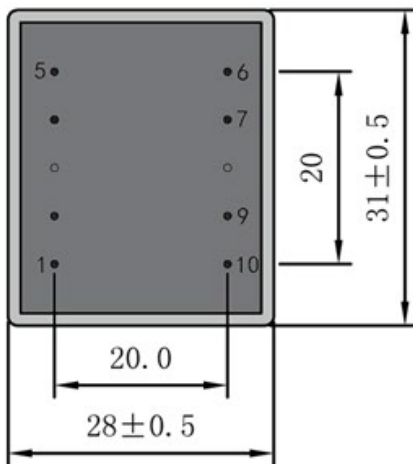

Dimensions with no indication of tolerances: ± 0.3mm
Custom-made transformer also will be welcome.

