

Type EI28/18

Power 2.0VA

Weight 100 g

shipping unit per box: 40 PCS

temperature class: ta 70°C/B

Safety transformer/Short circuit proof

Vacuum filled casting

Split bobbin design winding

Dielectric strength 4500Vrms

PART NO	Output ta 70°C/B	Prim.V	Connecting pins	Operating point sec. ± 10%	Connecting pins	No-load voltage V ± 10%
TG2818-U-0200-090-D	2.0 W	230	1--5	9V 111.1mA	6--7	13.2V
				9V 111.1mA	9--10	13.2V

According to

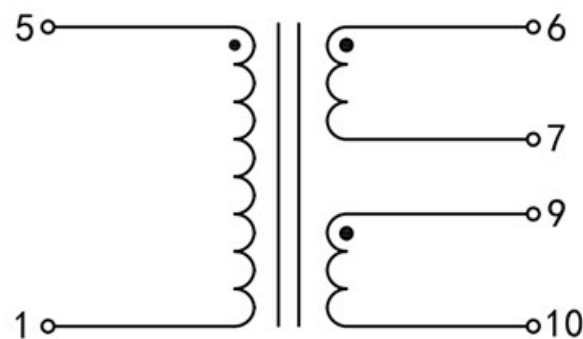
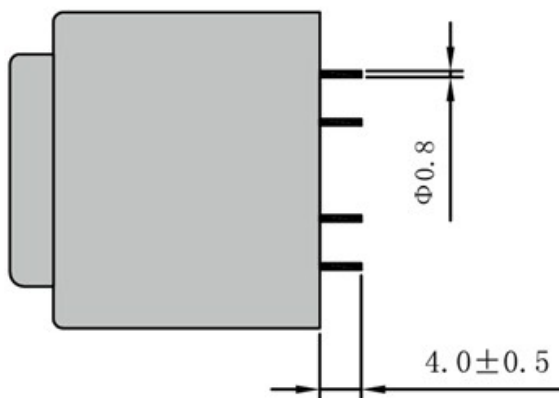
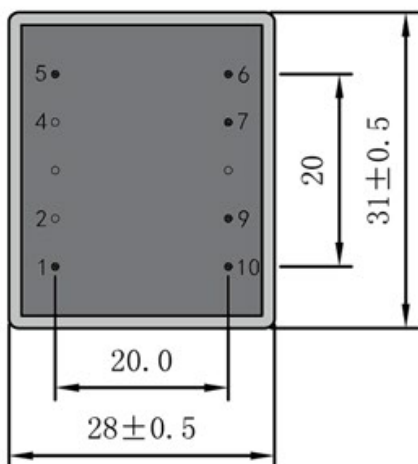

Dimensions with no indication of tolerances: ± 0.3mm
Custom-made transformer also will be welcome.

