

Type EI30/8

Power 0.8VA

Weight 60g

shipping unit per box: 40 PCS

temperature class: ta 70°C/B

Safety transformer/Short circuit proof

Vacuum filled casting

Split bobbin design winding

Dielectric strength 4500Vrms

PART NO	Output ta 70°C/B	Prim.V	Connecting pins	Operating point sec. ± 10%	Connecting pins	No-load voltage V ± 10%
TG3008-U2-0080-180-D	0.35W	115	1--2	18V 22.2mA	6--7	27.0V
		115	4--5	18V 22.2mA	9--10	27.0V

According to

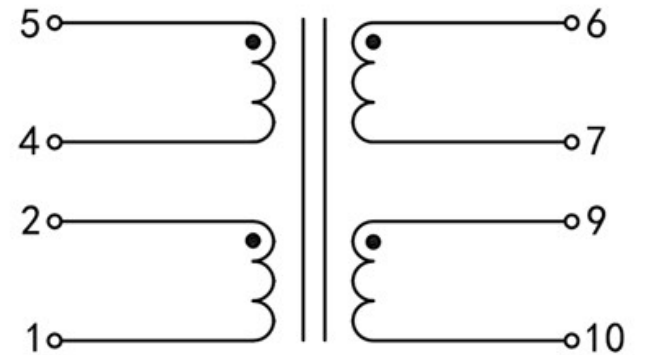
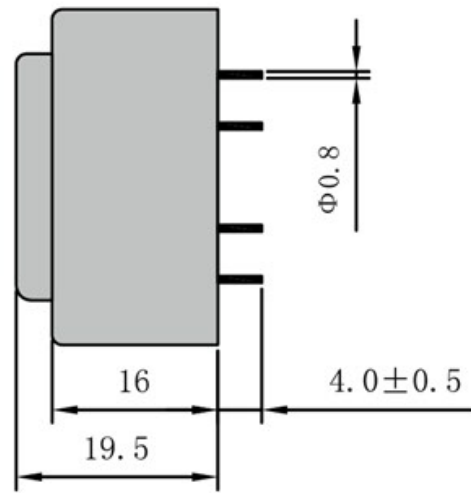
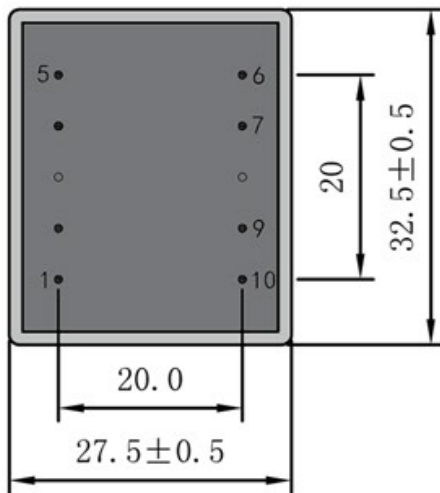

Dimensions with no indication of tolerances: ± 0.3mm
Custom-made transformer also will be welcome.

