

Type EI30/12.5

Power 1.5VA

Weight 85g

shipping unit per box: 40 PCS

temperature class: ta 70°C/B

Safety transformer/Short circuit proof

**Vacuum filled casting**

Split bobbin design winding

**with VDE, ENEC 10, UL ,CE,CB certificates**

Dielectric strength 4500Vrms

PART NO	Output ta 70°C/B	Prim.V	Connecting pins	Operating point sec. ± 10%	Connecting pins	No-load voltage V ± 10%
TG3012-U-0150-150-D	1.5W	115	1--5	15V 50.0mA	6--7	22.0V
				15V 50.0mA	9--10	22.0V

Approved by

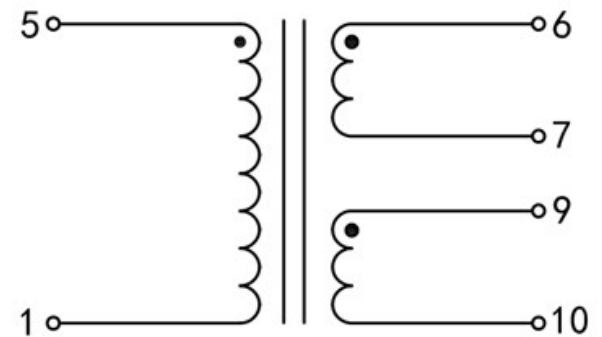
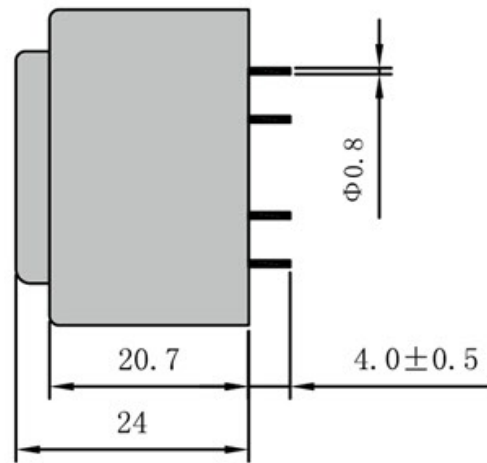
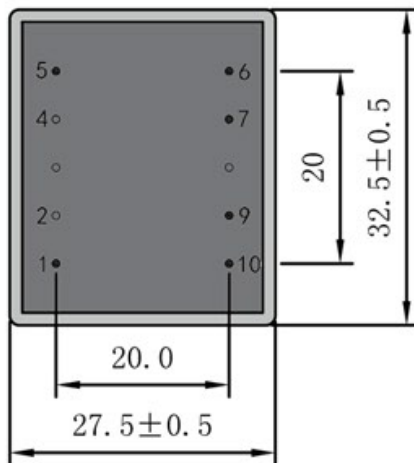

Dimensions with no indication of tolerances: ± 0.3mm  
Custom-made transformer also will be welcome.

