

Type EI30/12.5

Power 1.8VA

Weight 85g

shipping unit per box: 40 PCS

temperature class: ta 50°C/B

Safety transformer/Short circuit proof

Vacuum filled casting

Split bobbin design winding

with VDE, ENEC 10, UL, CE, CB certificates

Dielectric strength 4500Vrms

PART NO	Output ta 50°C/B	Prim.V	Connecting pins	Operating point sec. ± 10%	Connecting pins	No-load voltage V ± 10%
TG3012-U-0180-180-D	1.8W	115	1--5	18V 50.0mA	6--7	25.5V
				18V 50.0mA	9--10	25.5V

Approved by

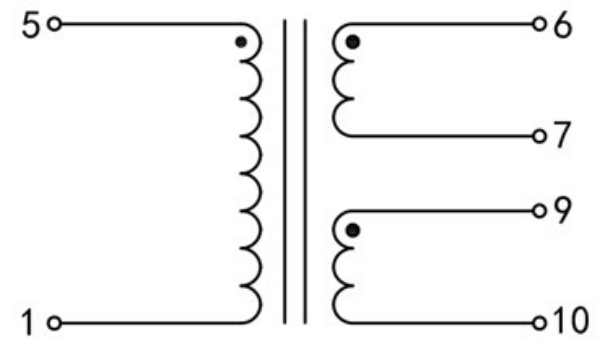
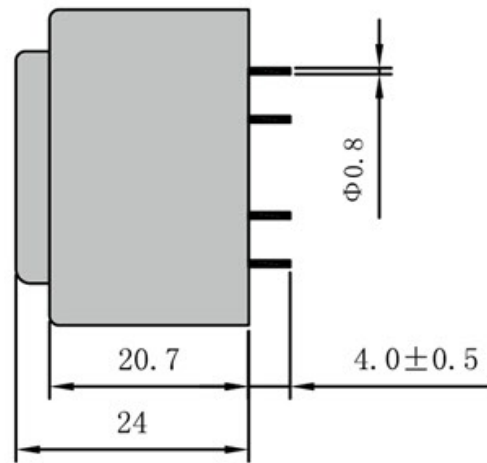
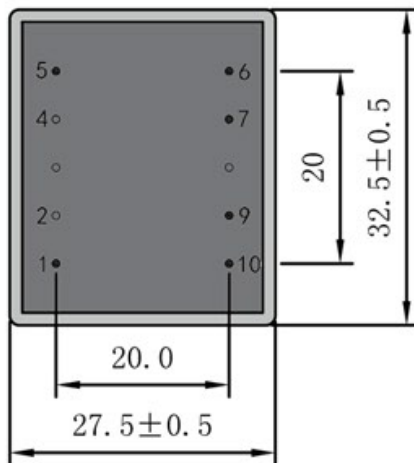

Dimensions with no indication of tolerances: ± 0.3mm
Custom-made transformer also will be welcome.

