

Type EI30/12.5

Power 1.0VA

Weight 80g

shipping unit per box: 40 PCS

temperature class: ta 70°C/B

**Max.standby power consumption ≤0.5W**

Safety transformer/Short circuit proof

**Vacuum filled casting**

Split bobbin design winding

**with VDE, ENEC 10, UL, CE, CB certificates**

Dielectric strength 4500Vrms

PART NO	Output ta 70°C/B	Prim.V	Connecting pins	Operating point sec. ± 10%	Connecting pins	No-load voltage V ± 10%
TG3012-E-0100-090-D	1.0W	230	1--5	9V 55.5mA	6--7	12.3V
				9V 55.5mA	9--10	12.3V

Approved by

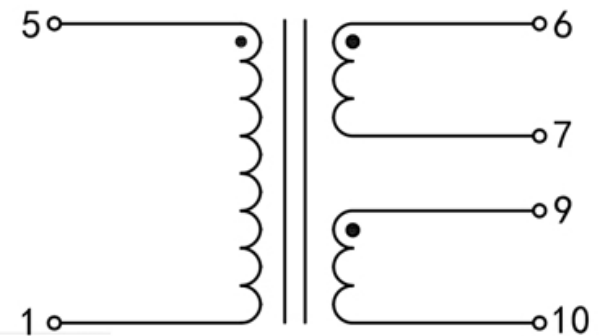
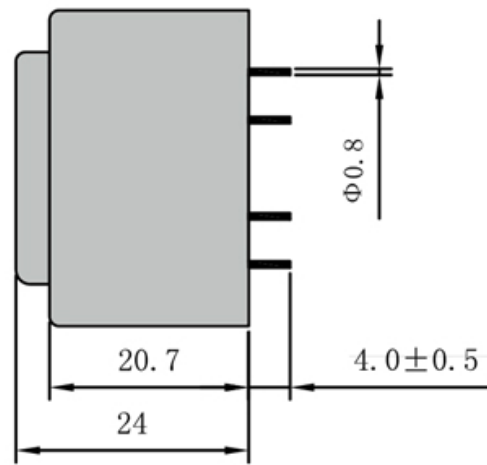
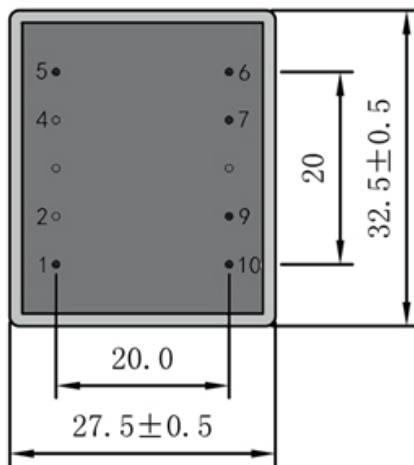

Dimensions with no indication of tolerances: ± 0.3mm  
Custom-made transformer also will be welcome.

