

Type EI54/18

Power 16.0VA

Weight 440g

shipping unit per box: 10 PCS

temperature class: ta 70°C/B

Vacuum filled casting

Split bobbin design winding

Dielectric strength 4500Vrms

PART NO	Output ta 70°C/B	Prim.V	Connecting pins	Operating point sec. ± 10%	Connecting pins	No-load voltage V ± 10%
TG5418-E-1600-090-D	16.0W	230	1--7	9V 888.8mA	8--9	11.3V
				9V 888.8mA	13--14	11.3V

According to

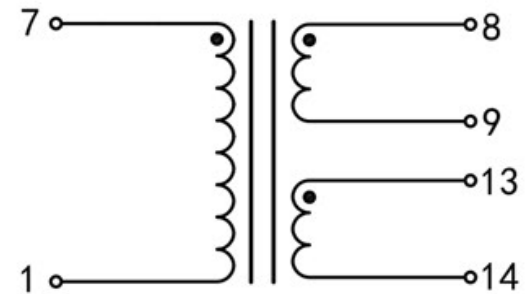
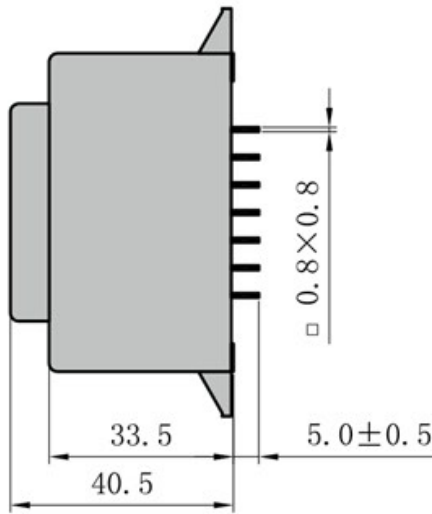
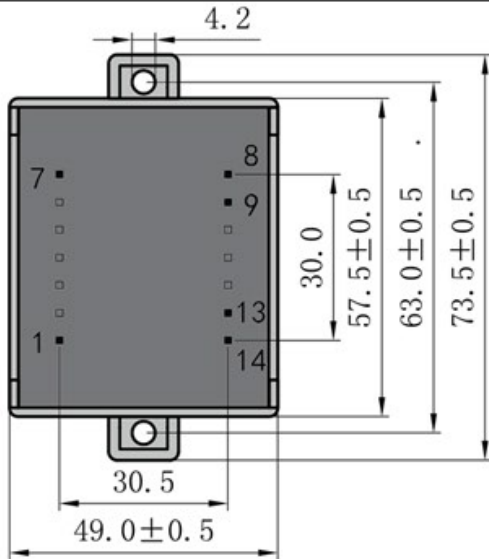

Dimensions with no indication of tolerances: ± 0.3mm
Custom-made transformer also will be welcome.

