

Type EI54/18

Power 16.0VA

Weight 440g

shipping unit per box: 10 PCS

temperature class: ta 70°C/B

**Vacuum filled casting**

Split bobbin design winding

**Dielectric strength 4500Vrms**

PART NO	Output ta 70°C/B	Prim.V	Connecting pins	Operating point sec. ± 10%	Connecting pins	No-load voltage V ± 10%
TG5418-U-1600-150-D	16.0W	115	1--7	15V 533.3mA	8--9	18.8V
				15V 533.3mA	13--14	18.8V

According to

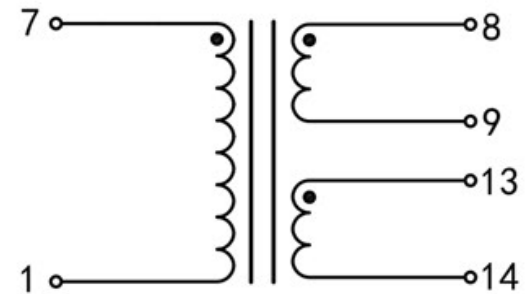
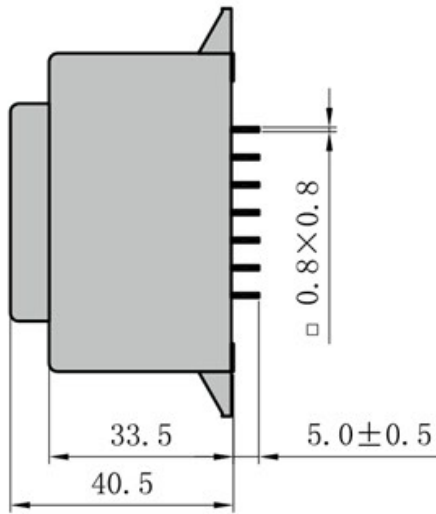
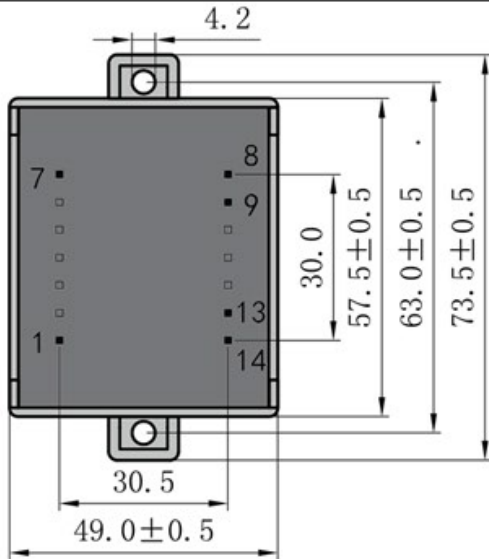

Dimensions with no indication of tolerances: ± 0.3mm  
Custom-made transformer also will be welcome.

