

Type EI60/30.5

Power 25.0VA

Weight 780g

shipping unit per box: 10 PCS

temperature class: ta 70°C/B

**Vacuum filled casting**

Split bobbin design winding

**Dielectric strength 4500Vrms**

PART NO	Output ta 70°C/B	Prim.V	Connecting pins	Operating point sec. ± 10%	Connecting pins	No-load voltage V ± 10%
TG6030-E-2500-060-D	25.0W	230	1--7	6V 2083.3mA	8--9	7.5V
				6V 2083.3mA	13--14	7.5V

According to

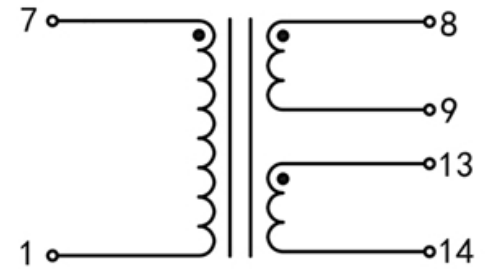
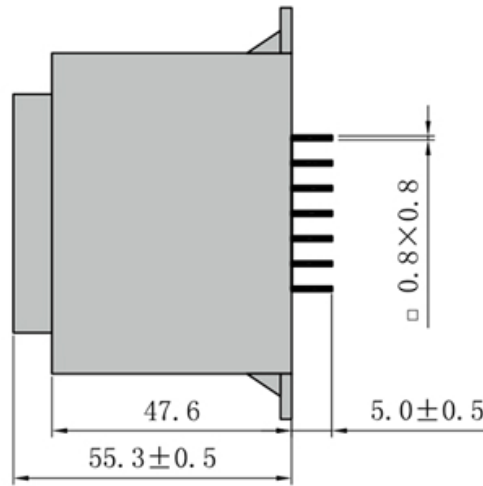
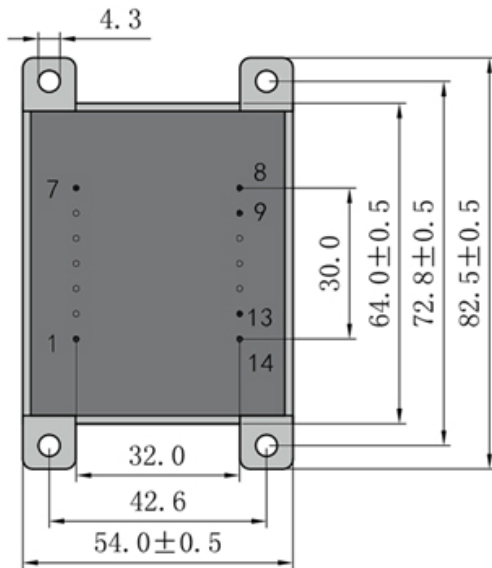

Dimensions with no indication of tolerances: ± 0.3mm  
Custom-made transformer also will be welcome.

