

Type EI60/30.5

Power 25.0VA

Weight 780g

shipping unit per box: 10 PCS.

temperature class: ta 70°C/B

**Vacuum filled casting**

Split bobbin design winding

**Dielectric strength 4500Vrms**

PART NO	Output ta 70°C/B	Prim.V	Connecting pins	Operating point sec. ± 10%	Connecting pins	No-load voltage ± 10%
TG6030-E-2500-180-S	25.0W	230	1--7	18V 1388.8mA	9--13	22.5V

According to

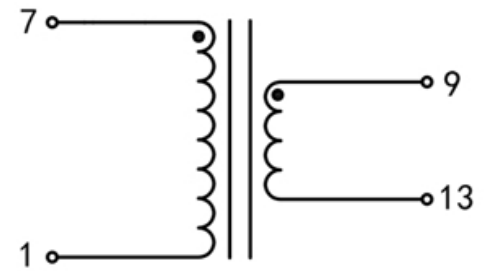
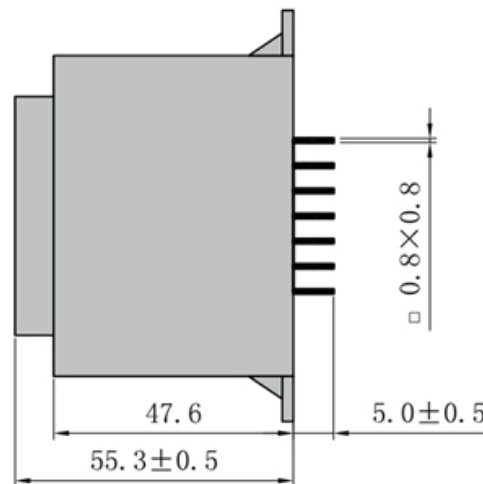
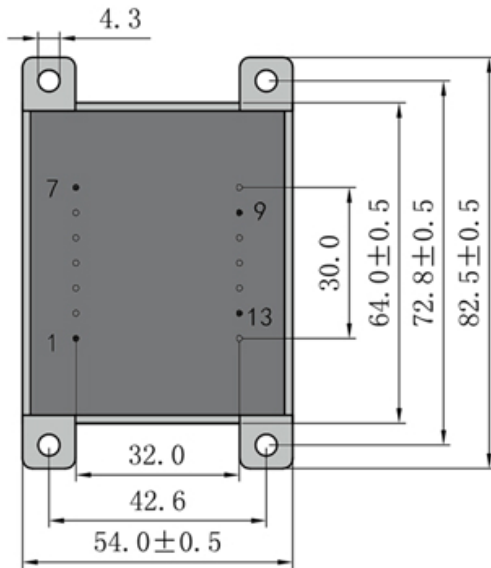

Dimensions with no indication of tolerances: ± 0.3mm  
Custom-made transformer also will be welcome.

