

Type EI60/30.5

Power 25.0VA

Weight 780g

shipping unit per box: 10 PCS

temperature class: ta 70°C/B

Vacuum filled casting

Split bobbin design winding

Dielectric strength 4500Vrms

PART NO	Output ta 70°C/B	Prim.V	Connecting pins	Operating point sec. ± 10%	Connecting pins	No-load voltage V ± 10%
TG6030-E-2500-240-D	25.0W	115	1--7	24V 520.8mA	8--9	30.0V
				24V 520.8mA	13--14	30.0V

According to

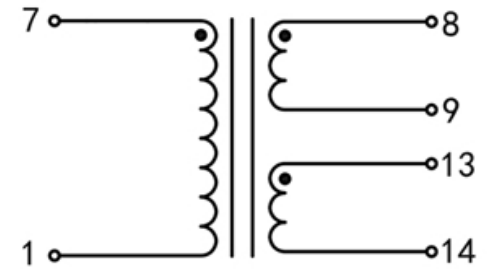
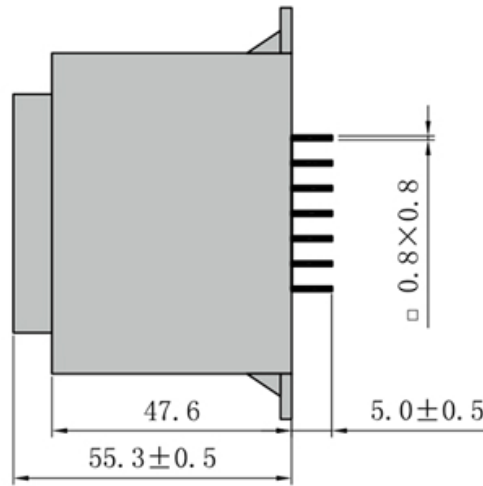
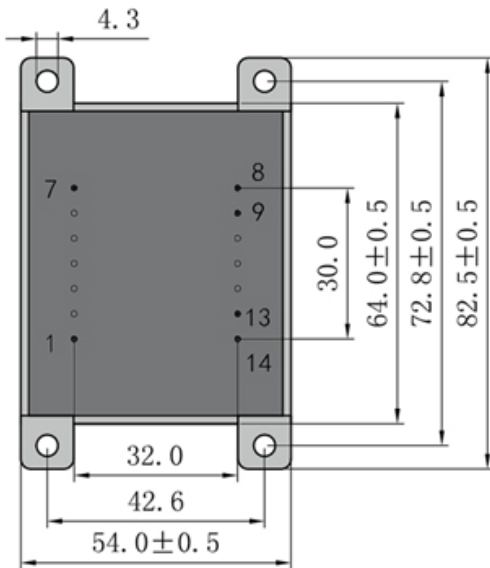

Dimensions with no indication of tolerances: ± 0.3mm
Custom-made transformer also will be welcome.

