

Type EI60/30.5

Power 25.0VA

Weight 780g

shipping unit per box: 10 PCS.

temperature class: ta 70°C/B

Vacuum filled casting

Split bobbin design winding

Dielectric strength 4500Vrms

| PART NO | Output ta 70°C/B | Prim.V | Connecting pins | Operating point sec. ± 10% | Connecting pins | No-load voltage ± 10% |
|---------------------|------------------|--------|-----------------|-------------------------------|-----------------|--------------------------|
| TG6030-U-2500-150-S | 25.0W | 115 | 1--7 | 15V 1666.6mA | 9--13 | 18.8V |

According to

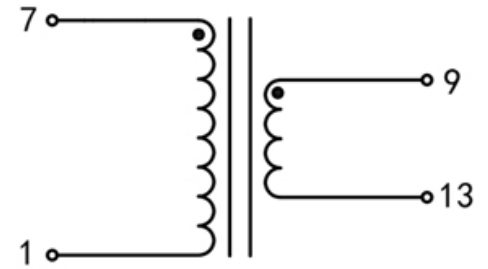
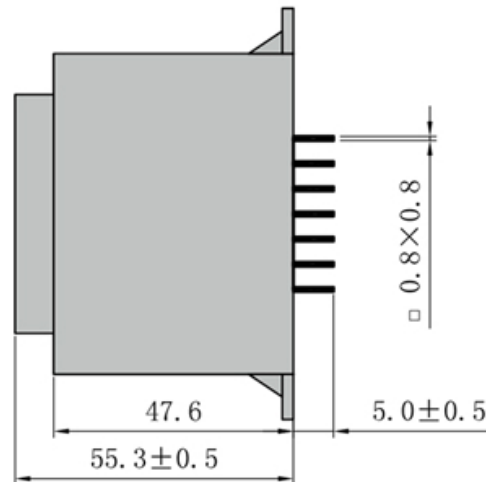
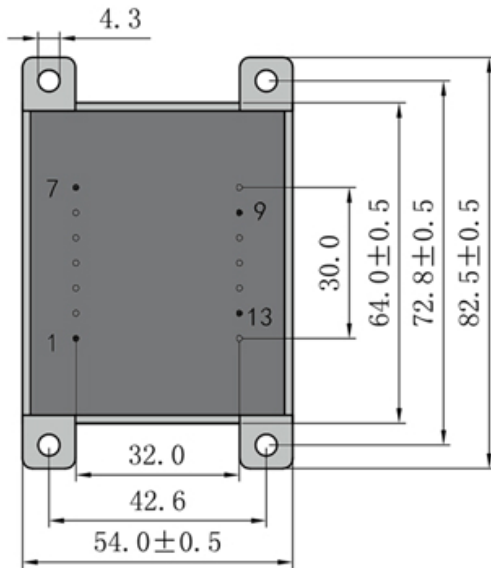

Dimensions with no indication of tolerances: ± 0.3mm
Custom-made transformer also will be welcome.

