

Outline:

- Small footprint power inductors designed for maximum efficiency And low cost
- Industry-standard pin spacings
- Magnetic shielding to minimize EMI
- In addition to the standard versions of inductors shown here custom inductors are available to meet your exact requirements

Features:

- Core material:Ferrite
- Enviromental: RoHS, Reach compliant ,Halogen free
- Weight:2.89g
- Moisture Sensitivity:Level (MSL) 1 (unlimited floor life at <30°C / 85% relative humidity).
- Operating temperature range: -40°C~+125°C (including coil's self temperature rise)
- Storage temperature range: -40°C~+125°C

Application:

- Ideal for noise filtering in power amplifiers,power supplies and Speaker crossover networks.
- buck converter,network communication equipment, and etc

1 Electrical Characteristics

Part No.	Inductance (μH)※1	D.C.R. (mΩ)		Isat (A)※2	Irms (A) ※3
		Typical	Max	Typical	Typical
TGIJ1010-100M	10.0	18.2	21.8	4.50	5.12
TGIJ1010-150M	15.0	22.0	26.4	3.40	4.66
TGIJ1010-220M	22.0	26.9	32.3	3.00	4.21
TGIJ1010-330M	33.0	41.0	49.2	2.40	3.41
TGIJ1010-470M	47.0	59.0	70.8	2.10	2.85
TGIJ1010-680M	68.0	79.0	94.8	1.75	2.46
TGIJ1010-820M	82.0	100	120	1.60	2.19
TGIJ1010-101M	100	111	133	1.45	2.07
TGIJ1010-151M	150	182	218	1.20	1.62
TGIJ1010-221M	220	233	280	0.95	1.43
TGIJ1010-331M	330	373	448	0.80	1.13
TGIJ1010-471M	470	443	532	0.70	1.04
TGIJ1010-681M	680	669	803	0.60	0.85
TGIJ1010-821M	820	864	1,037	0.53	0.74
TGIJ1010-102M	1,000	1,000	1,200	0.45	0.69

2 Product Dimensions (mm)

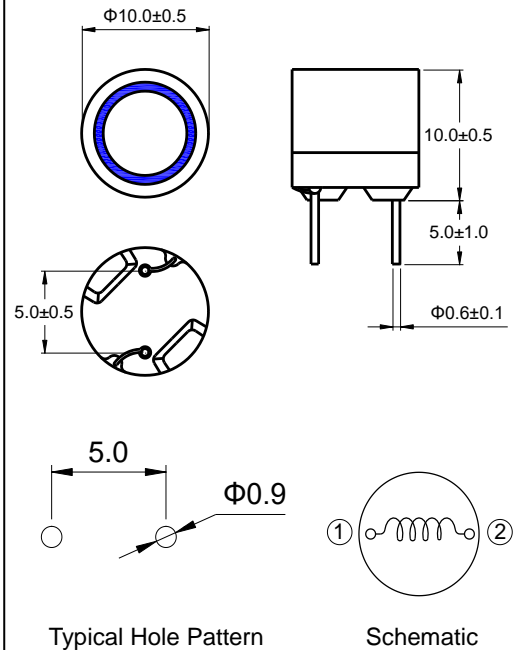

All data is tested on 25°C ambient temperature

1. Inductance measure condition at 100kHz,0.1V
2. Isat:the actual value of DC current when the Inductance decrease 20% of its initial value
3. Irms:the actual value of DC current when the the temperature rise is ΔT40°C(Ta=25°C)

3 Saturation Current vs Temperature Rise Current Curve

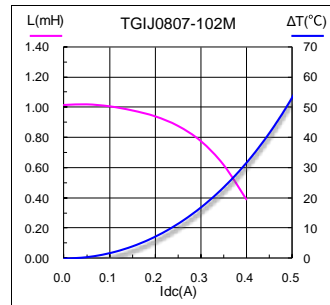
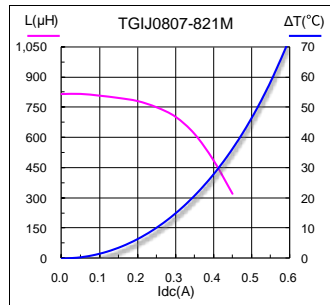
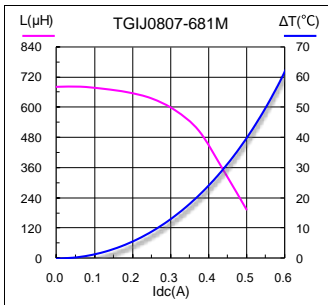
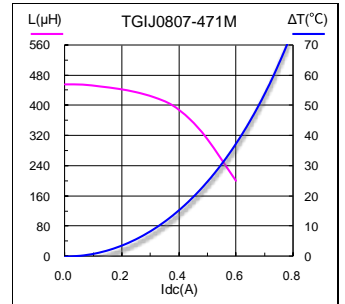
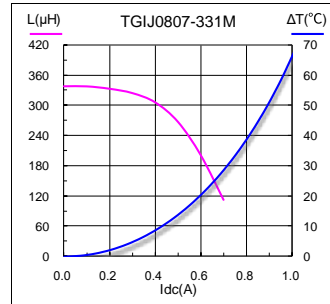
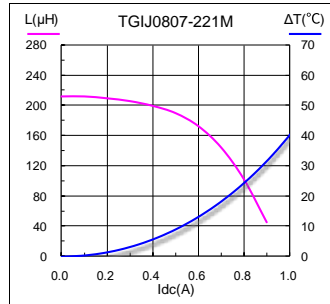
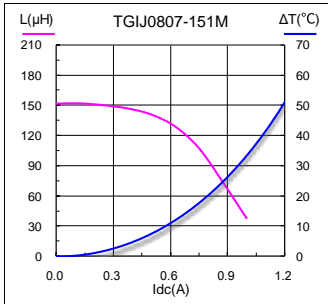
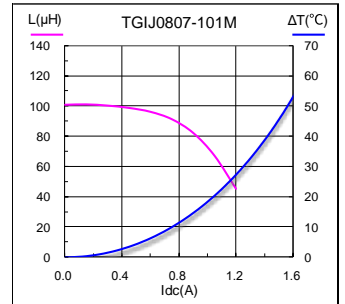
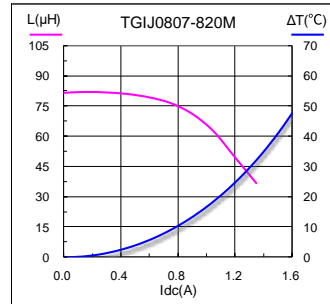
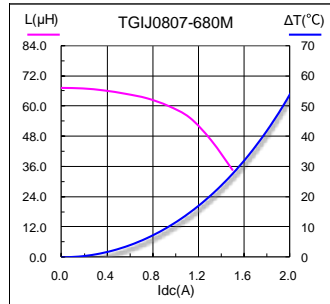
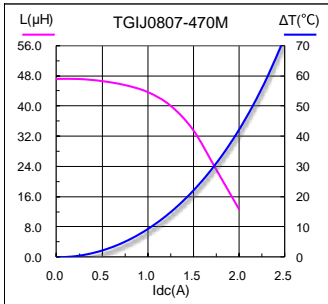
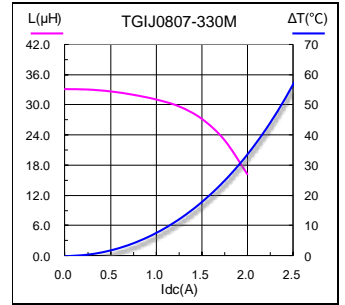
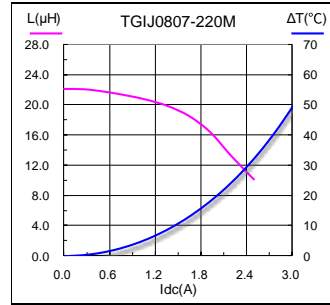
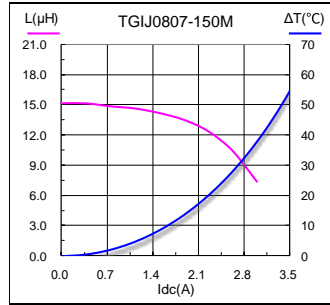
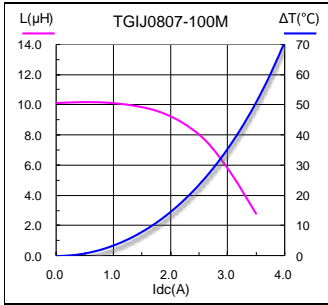

4 Packing Specification

4.1 Packing

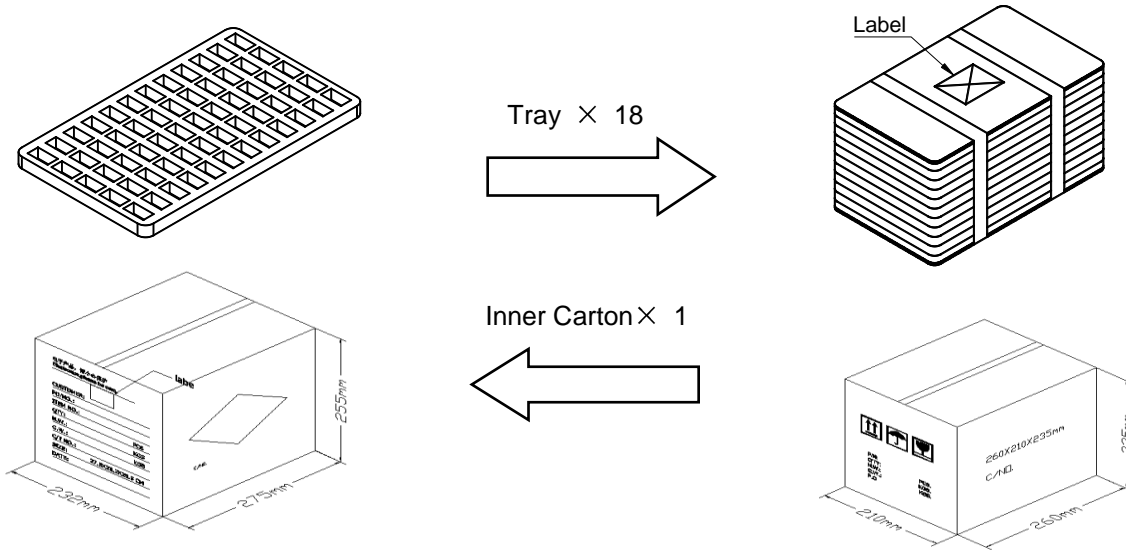

4.2 Carton Dimensions and Packing Quantity

■ Inner Carton: 260×210×235mm

■ Out Carton : 275×232×255mm

Product Series	Quantity / Bag	Inner Carton Quantity	Out Carton Quantity
TGIJ1010	120pcs	(120 × 18) = 2160pcs	(2160 × 1) = 2160pcs

4.3 Label Making

The following items will be marked on the tray of product label and shipping label.

Production Label
■ Packing No.
■ Quantity
■ Shipment Date
■ Part No.
■ Customer Part No.
■ Customer Po No.

Shipping Label
■ Packing No.
■ Quantity
■ Shipment Date
■ Part No.
■ Customer Part No.
■ Customer Po No.

5 Notice of Use

- 5.1 Special remind: Circuit design, component placement, PCB size and thickness, cooling system and etc. all will affect the product temperature. Please verify the product temperature in the final application.
- 5.2 Product in packing storage condition: temperature 5~40°C, RH≤70%.
If taking out for use, the remaining products should be sealed in plastic bags and preserved in accordance with the above conditions, to avoid oxidation of terminals (electrodes), affecting soldering status.
- 5.3 A storage of Codaca Electronic products for longer than 12 months is not recommended, Within other effects, the terminals may suffer degradation, resulting in bad solderability. Therefore, all products shall be used within the period of 12 months based on the day of shipment.
- 5.4 Do not keep products in unsuitable storage conditions, such as areas susceptible to high temperatures, high humidity, dust or corrosion.
- 5.5 Always handle products with care.
- 5.6 Don't touch electrodes directly with bare hands as oil secretions may inhibit soldering.
Always ensure optimum conditions for soldering.
- 5.7 When this product will be used on a similar or new project to the original one, sometimes it might be unable to satisfy the specifications due to different condition of usage.
- 5.8 This inductor itself does not have any protective function in abnormal condition, such as overload, short-circuit, open-circuit conditions, etc. Therefore, it shall be confirmed that there is no risk of smoke, fire, dielectric withstand voltage, insulation resistance, etc., or use in abnormal conditions protective devices or protection circuit in the end product.
- 5.9 Hi-Pot test with higher voltage than spec value will damage insulating material and shorten its life.
- 5.10 If using in potting compound, the magnet wire coating might be damaged, please consult with us.
- 5.11 Refrain from rinsing coils. If necessary, please consult with us.