

Outline:

- Ferrite core technology provides stable inductance saturation current and low core loss at operating
- Very reliable mechanical design
- High Current capability
- In addition to the standard versions of inductors shown here custom inductors are available to meet your exact requirements

Features:

- Core material: Ferrite
- Environmental: RoHS compliant, halogen free
- Weight: 4.20
- Moisture Sensitivity: Level (MSL) 1 (unlimited floor life at <30°C / 85% relative humidity)
- Operating temperature range: -40°C ~ +125°C (including coil's self temperature rise).
- Storage temperature range: -40°C ~ +125°C

Application:

- Standard filter applications
- EMC Suppression in motor drive systems
- In over all application in infotainment systems

1 Appearance and Dimensions (mm)

2 Schematic

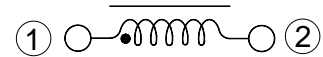
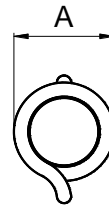
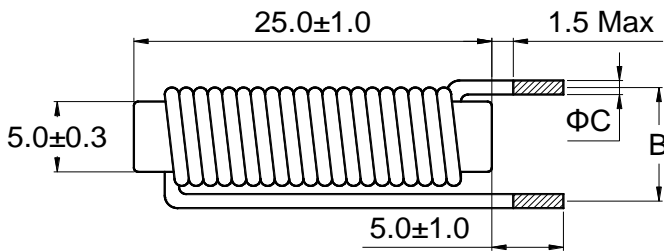

3 Reference Hole Pattern (mm)

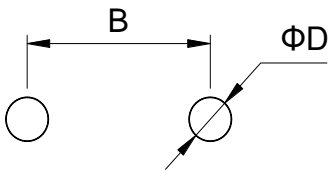

Part No. 型号	A	B	C	D
	Max	±1.0	±0.15	Ref.
4R7	8.20	10.0	1.30	1.70
5R0	8.20	10.0	1.30	1.70
6R8	7.80	9.00	1.10	1.50
8R2	7.50	8.50	1.00	1.40
100	7.30	8.50	0.90	1.30
150	6.90	7.50	0.70	1.10
220	6.80	7.30	0.60	1.00

4 Electrical Characteristics

Part No.	Inductance (μH) ※1 ±20%	D.C.R. (mΩ)		Saturation current (A) ※2 Typical	Temperature rise current (A) ※3 Typical
		Typical	Max		
TGRE0525-4R7M	4.70	4.30	5.60	11.5	15.0
TGRE0525-5R0M	5.00	4.50	5.90	11.0	14.7
TGRE0525-6R8M	6.80	7.15	9.29	9.50	11.7
TGRE0525-8R2M	8.20	8.90	11.6	8.50	10.5
TGRE0525-100M	10.0	11.7	15.2	7.50	9.10
TGRE0525-150M	15.0	23.3	30.3	6.00	6.50
TGRE0525-220M	22.0	37.8	49.1	4.50	5.00

■ All data is tested based on 25°C ambient temperature.

※1 Inductance measure condition at 1kHz, 0.25V.

※2 Saturation current: the actual value of DC current when the inductance decrease 20% of its initial value.

※3 Temperature rise current: the actual value of DC current when the temperature rise is $\Delta T 40^{\circ}\text{C}$ ($T_a=25^{\circ}\text{C}$).

※ Special remind: Circuit design, component placement, PCB size and thickness, cooling system and etc. all will affect the product temperature. Please verify the product temperature in the final application.

5 Saturation Current vs Temperature Rise Current Curve

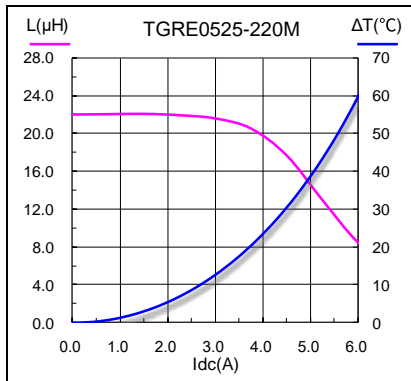
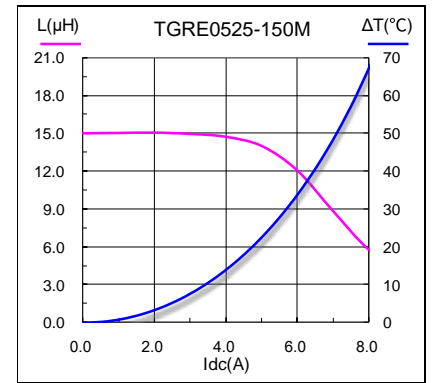
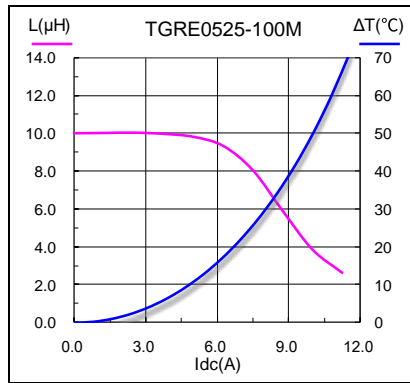
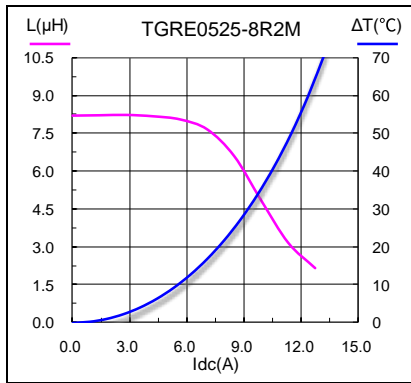
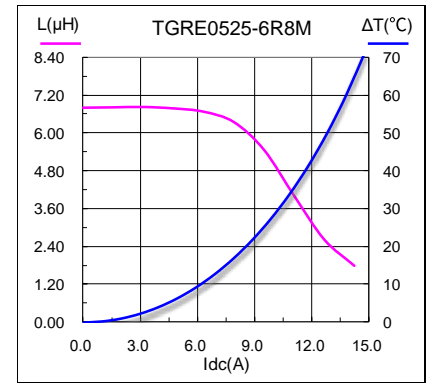
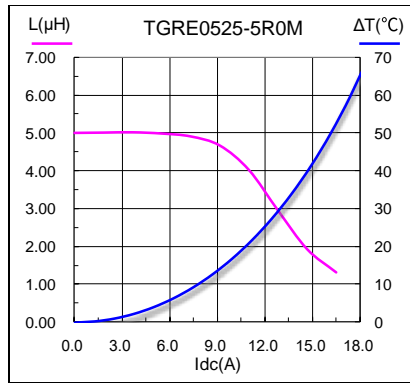
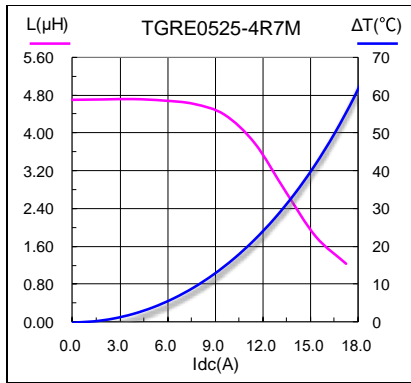

6 Packing Specification

6.1 Plastic Tray Dimensions (mm)

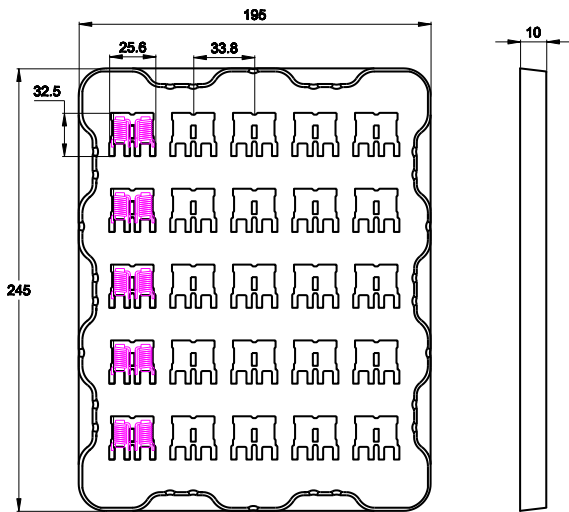

Packaging Unit (Pcs)	Material
50	APET

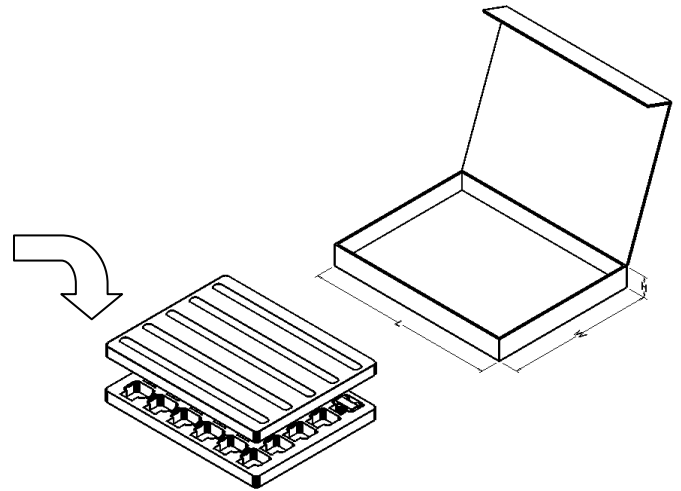

L typ	W typ	H typ	No. of Tray (Pcs)	Packaging Unit(Pcs)	Material
265	205	25	2	100	Paper

6.2 Packing(mm)

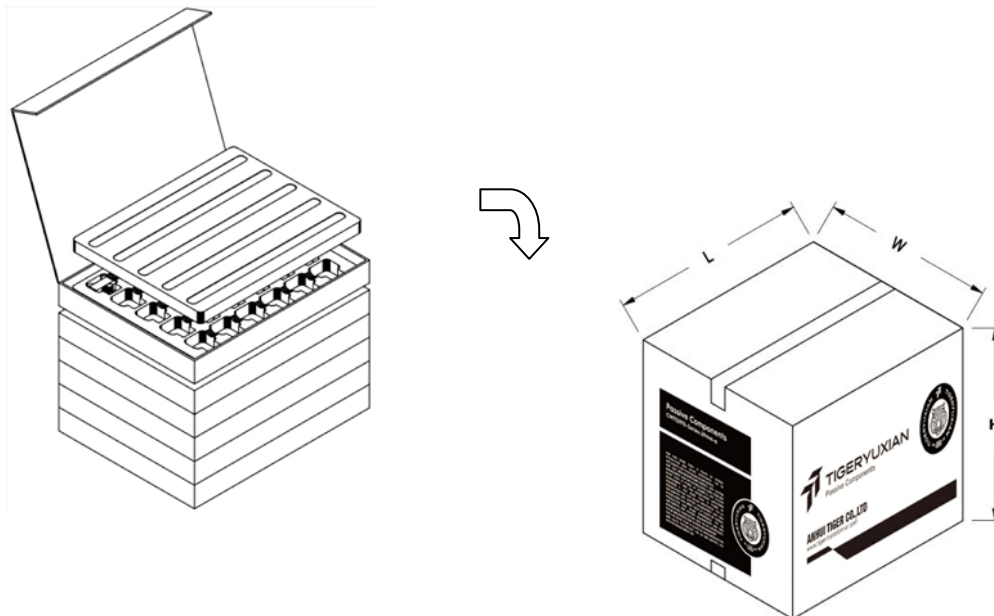

L typ	W typ	H typ	No. of Inner Carton	Packaging Unit(Pcs)	Material
275	232	255	9	900	Paper

7 Notice of Use

- 7.1 Special remind:Circuit design, component placement, PCB size and thickness, cooling system and etc. all will affect the product temperature. Please verify the product temperature in the final application.
- 7.2 Product in packing storage condition:temperature 5~40°C, RH≤70%.
If taking out for use, the remaining products should be sealed in plastic bags and preserved in accordance with the above conditions, to avoid oxidation of terminals (electrodes), affecting soldering status.
- 7.3 A storage of Codaca Electronic products for longer than 12 months is not recommended, Within other effects, the terminals may suffer degradation, resulting in bad solderability. Therefore, all products shall be used within the period of 12 months based on the day of shipment.
- 7.4 Do not keep products in unsuitable storage conditions, such as areas susceptible to high temperatures, high humidity, dust or corrosion.
- 7.5 Always handle products with care.
- 7.6 Don't touch electrodes directly with bare hands as oil secretions may inhibit soldering.
Always ensure optimum conditions for soldering.
- 7.7 When this product will be used on a similar or new project to the original one, sometimes it might be unable to satisfy the specifications due to different condition of usage.
- 7.8 This inductor itself does not have any protective function in abnormal condition, such as overload, short-circuit, open-circuit conditions, etc. Therefore, it shall be confirmed that there is no risk of smoke, fire, dielectric withstand voltage, insulation resistance, etc., or use in abnormal conditions protective devices or protection circuit in the end product.
- 7.9 Hi-Pot test with higher voltage than spec value will damage insulating material and shorten its life.
- 7.10 If using in potting compound, the magnet wire coating might be damaged, please consult with us.
- 7.11 Refrain from rinsing coils. If necessary, please consult with us.