

Outline:

- 3 pins structure design, improved reliability.
- Flat wire winding, achieve a low D.C. Resistance.
- Symmetrical air gap , improve saturation current capability.

Features:

- Core material: Mn-Zn Ferrite
- Enviromental: RoHS, Reach compliant ,Halogen free
- Weight:27.5~40.7 g
- Moisture Sensivity:Level (MSL) 1 (unlimited floor life at <30°C / 85% relative humidity).
- Operating temperature range: -55°C ~ +150°C (including coil's self temperature rise)
- Storage temperature range: -55°C ~ +150°C

Application:

- DC-DC converters
- VRM (Voltage Regulator Modules) converters
- PoL(Point of Load) converters
- Solar converters

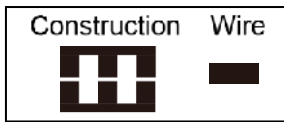

1 Electrical Characteristics

Part No.	L (μH) $\times 1$	D.C.R. ($\text{m}\Omega$)		Isat (A) $\times 2$		Irms (A) $\times 3$	H (mm)
	$\pm 10\%$	Typ.	Max.	Typ. 25°C	Typ. 100°C	Typ.	± 0.4
TGRV2711-1R0K	1.00	0.46	0.56	101.5	89.5	54.0	11.9
TGRV2711-1R5K	1.50	0.46	0.56	67.0	59.5	54.0	11.9
TGRV2713-2R2K	2.20	0.68	0.82	74.1	63.2	47.3	13.5
TGRV2714-3R3K	3.30	0.88	1.06	67.2	57.4	42.5	14.9
TGRV2714-4R7K	4.70	1.39	1.67	59.3	52.1	37.2	14.6
TGRV2715-6R8K	6.80	1.66	1.99	45.5	38.0	35.0	15.8
TGRV2716-100K	10.0	1.92	2.30	35.0	30.3	33.1	16.9
TGRV2716-150K	15.0	1.92	2.30	23.0	20.5	33.1	16.9

All data is tested on 25°C ambient temperature

1. Inductance measure condition at 100kHz,0.1V
2. Isat:the actual value of DC current when the inductance decrease 20% of its initial value
3. Iirms:the actual value of DC current when the temperature rise is $\Delta T 40^\circ\text{C}$ ($T_a=25^\circ\text{C}$)

2 Product Dimensions (mm)

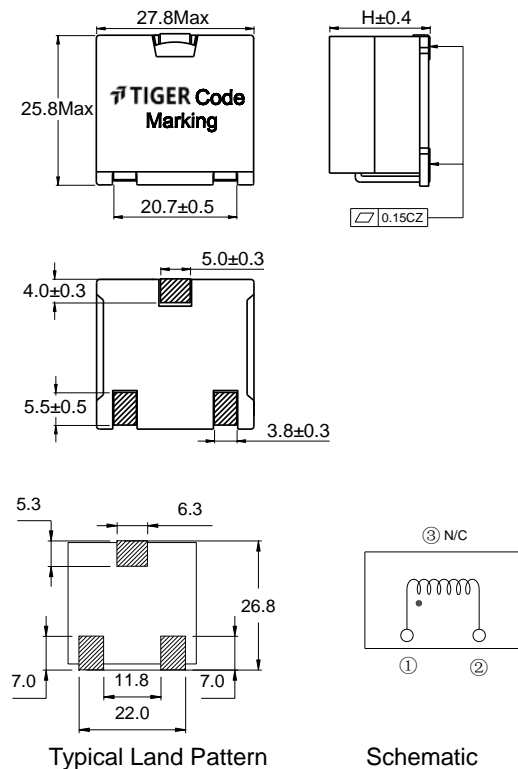

3 How to Order

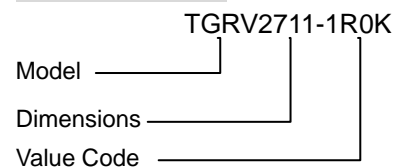

4 Saturation Current vs Temperature Rise Current Curve

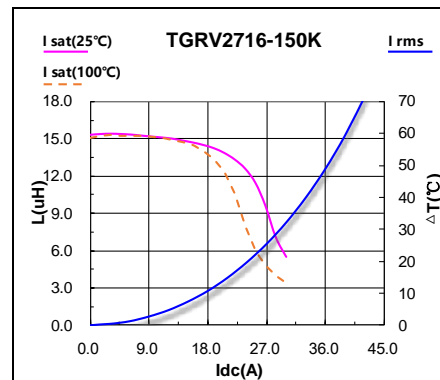
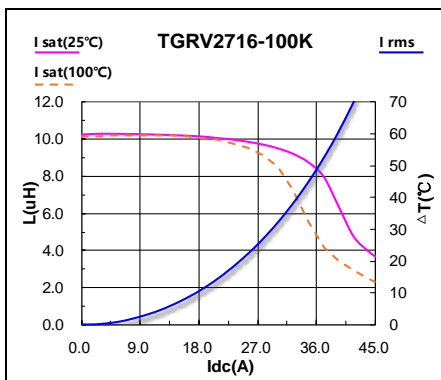
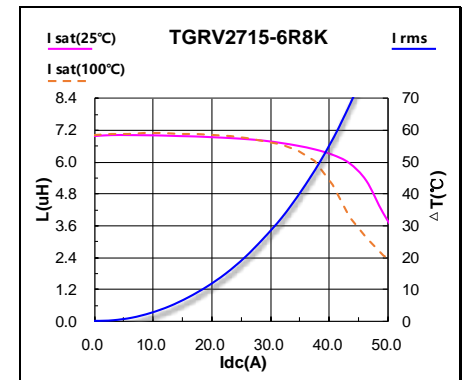
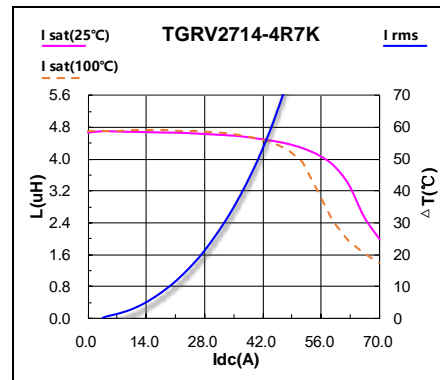
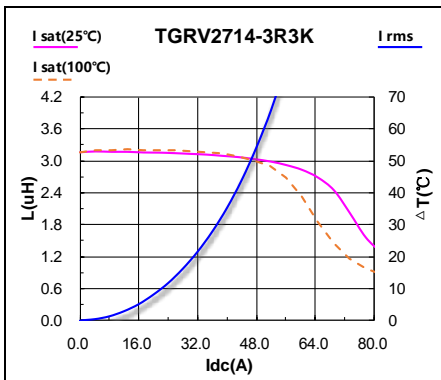
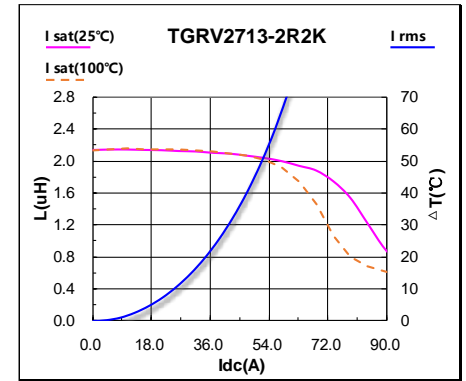
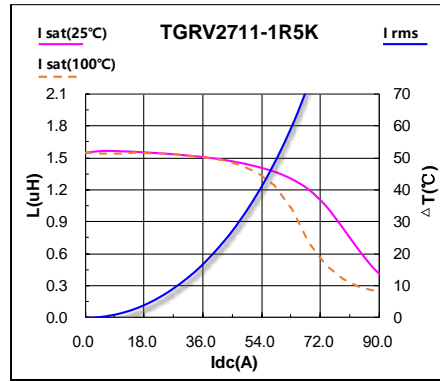
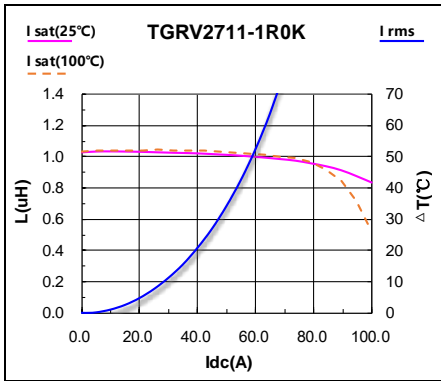

5 Packing Specification

5.1 Carrier Tape Dimensions (mm)

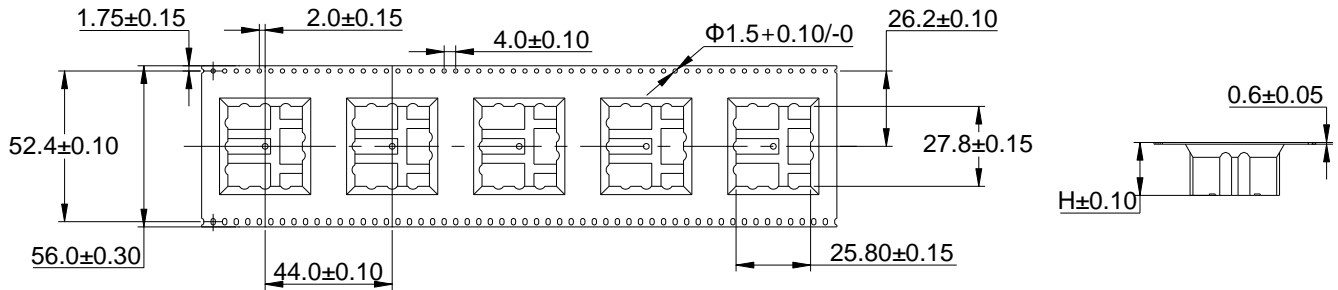

Product Series	VSRU2711-Serise	VSRU2713&14-Serise	VSRU2715&16-Serise
Hight (H)	13.4	16.4	18.4

※ Packing is referred to the international standard IEC 60286-3.

5.2 Reel Dimensions (mm)

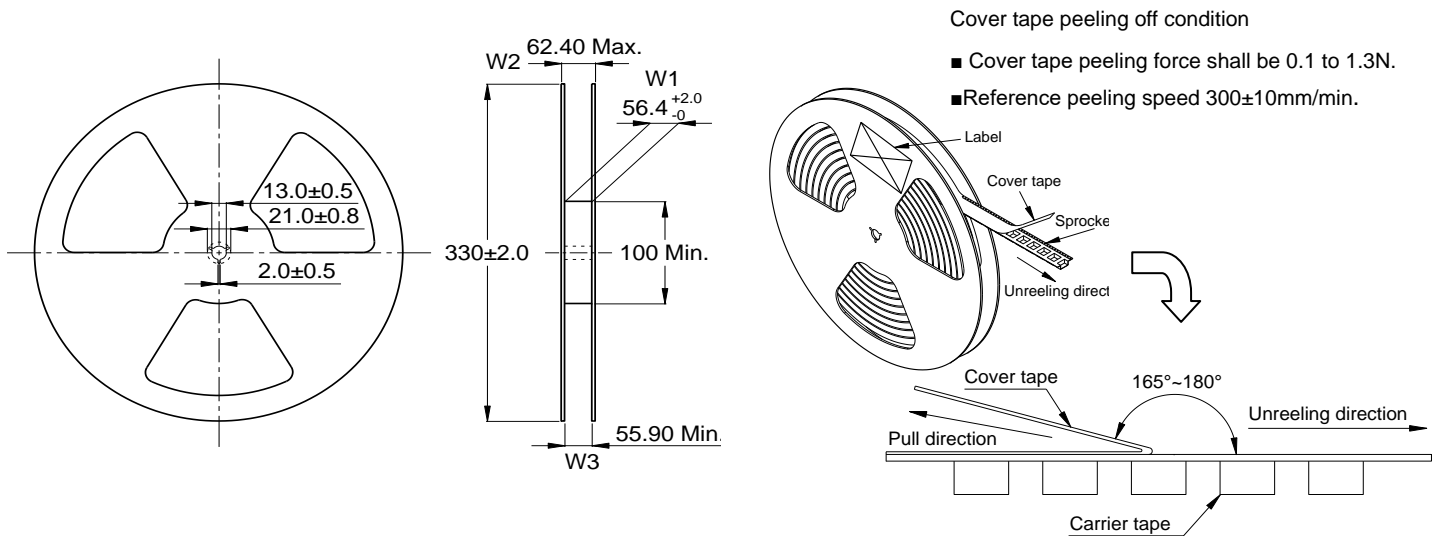

5.3 Carton Dimensions and Packing Quantity

- Inner Carton : $340 \times 340 \times 95$ mm
- Out Carton : $360 \times 360 \times 370$ mm

Product Series	Quantity / Reel	Inner Carton Quantity	Out Carton Quantity
TGRV2711-Serise	100pcs	100pcs	300pcs
TGRV2713&14-Serise	80pcs	80pcs	240pcs
TGRV2715&16-Serise	65pcs	65pcs	195pcs

6 Soldering Specification

6.1 Reflow Profile for SMT Components

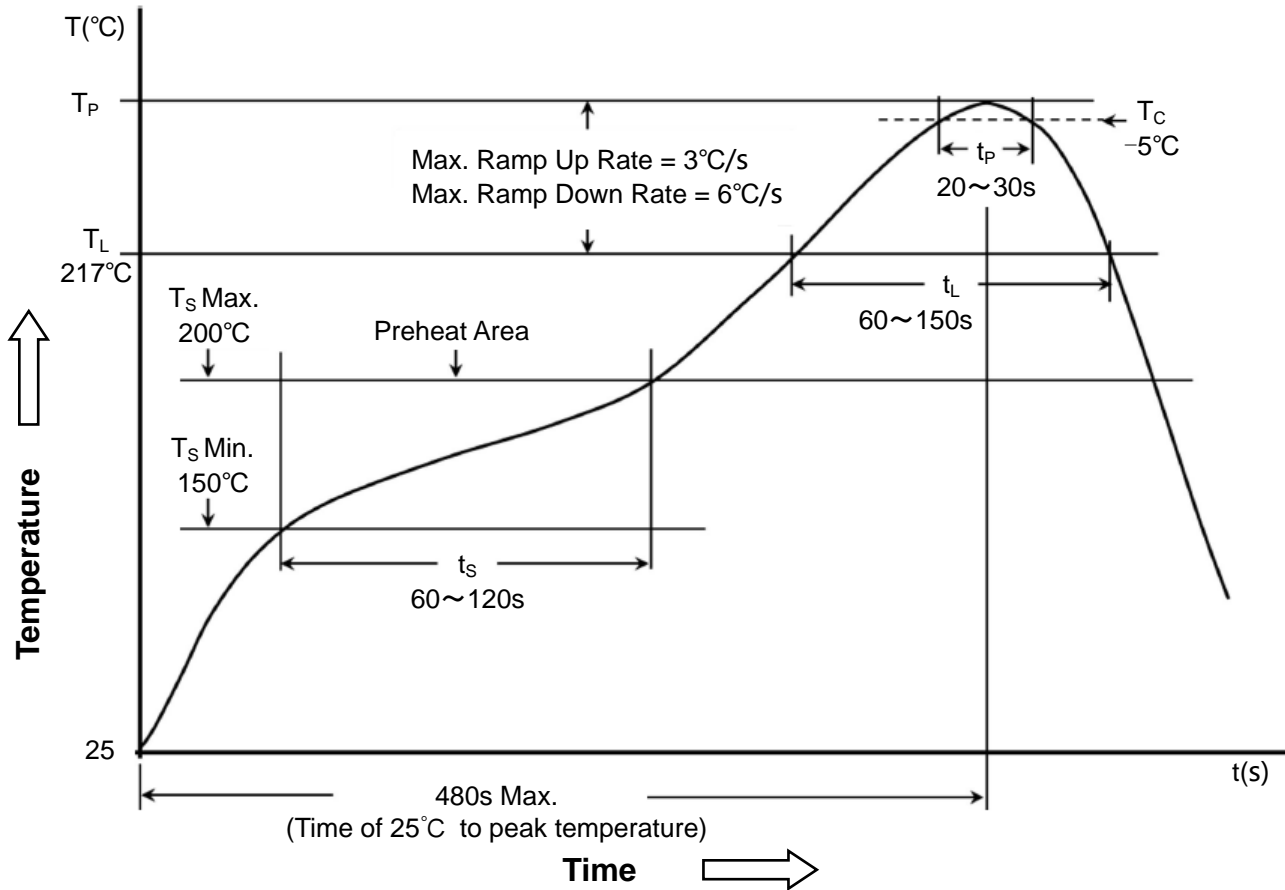

6.2 Classification of Peak Package Body Temperature (Tp)

	Package Thickness	Package Volume		
		<350 mm ³	350 ~ 2000 mm ³	>2000 mm ³
PB-Free Assembly	<1.6mm	260°C	260°C	260°C
	1.6 ~ 2.5mm	260°C	250°C	245°C
	≥2.5mm	250°C	245°C	245°C

※ Reflow is referred to standard IPC/JEDEC J-STD-020D.

7 Notice of Use

- 7.1 Special remind:Circuit design, component placement, PCB size and thickness, cooling system and etc. all will affect the product temperature. Please verify the product temperature in the final application.
- 7.2 Product in packing storage condition:temperature 5 ~ 40°C, RH≤ 70%.
If taking out for use, the remaining products should be sealed in plastic bags and preserved in accordance with the above conditions, to avoid oxidation of terminals (electrodes), affecting soldering status.
- 7.3 A storage of Codaca Electronic products for longer than 12 months is not recommended, Within other effects, the terminals may suffer degradation, resulting in bad solderability. Therefore, all products shall be used within the period of 12 months based on the day of shipment.
- 7.4 Do not keep products in unsuitable storage conditions, such as areas susceptible to high temperatures, high humidity, dust or corrosion.
- 7.5 Always handle products with care.
- 7.6 Don't touch electrodes directly with bare hands as oil secretions may inhibit soldering.
Always ensure optimum conditions for soldering.
- 7.7 When this product will be used on a similar or new project to the original one, sometimes it might be unable to satisfy the specifications due to different condition of usage.
- 7.8 This inductor itself does not have any protective function in abnormal condition, such as overload, short-circuit, open-circuit conditions, etc. Therefore, it shall be confirmed that there is no risk of smoke, fire, dielectric withstand voltage, insulation resistance, etc., or use in abnormal conditions protective devices or protection circuit in the end product.
- 7.9 Hi-Pot test with higher voltage than spec value will damage insulating material and shorten its life.
- 7.10 If using in potting compound, the magnet wire coating might be damaged, please consult with us.
- 7.11 Refrain from rinsing coils. If necessary, please consult with us.