

Type **UI30/5.5**

Power **2.0 VA**

Weight **125g**

shipping unit per box: **18 pcs** temperature class: **ta 50°C/B**

Vacuum filled casting

Split bobbin design winding

Dielectric strength 3750Vrms

PART NO	Output ta 50°C/B	Prim.V	Connecting pins	Operating point sec. ± 10%	Connecting pins	No-load voltage V ± 10%
TG3005-U2-0200-060-D	2.0 W	115	1---3	6V 166.6mA	10---12	10.2V
		115	5---7	6V 166.6mA	14---16	10.2V

According to

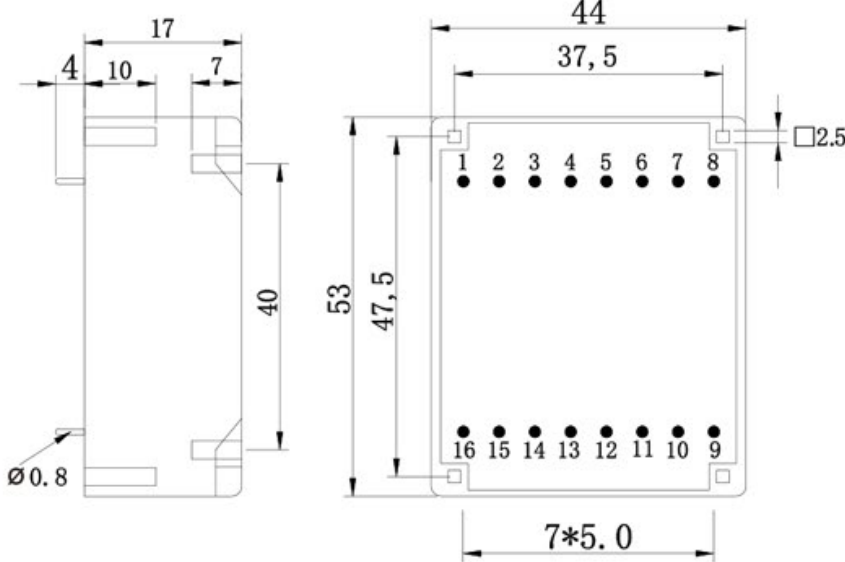

Schematics

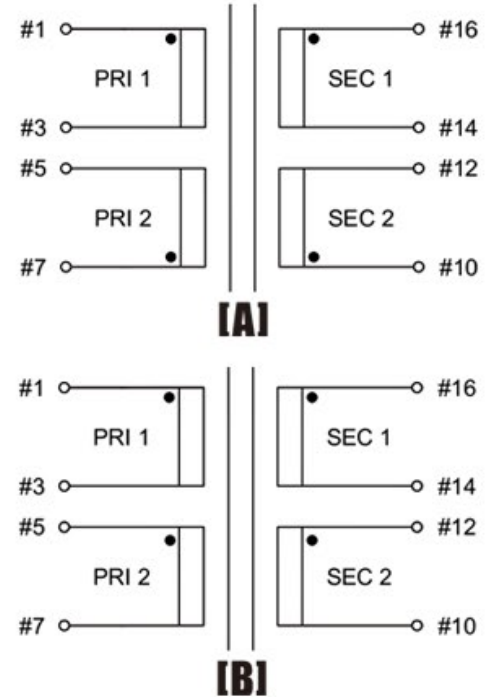

Tolerances : <10mm ±0.3mm
10--50mm ±0.5mm

Custom-made transformer also will be welcome.

