

Type **UI30/10.5**

Power **6.0 VA**

Weight **185g**

shipping unit per box: **18 pcs**      temperature class: **ta 50°C/B**

**Vacuum filled casting**

Split bobbin design winding

**Dielectric strength 3750Vrms**

PART NO	Output ta 50°C/B	Prim.V	Connecting pins	Operating point sec. ± 10%	Connecting pins	No-load voltage V ± 10%
TG3010-U2-0600-240-D	6.0 W	115	1---3	24V 125.0mA	10---12	32.3V
		115	5---7	24V 125.0mA	14---16	32.3V

According to

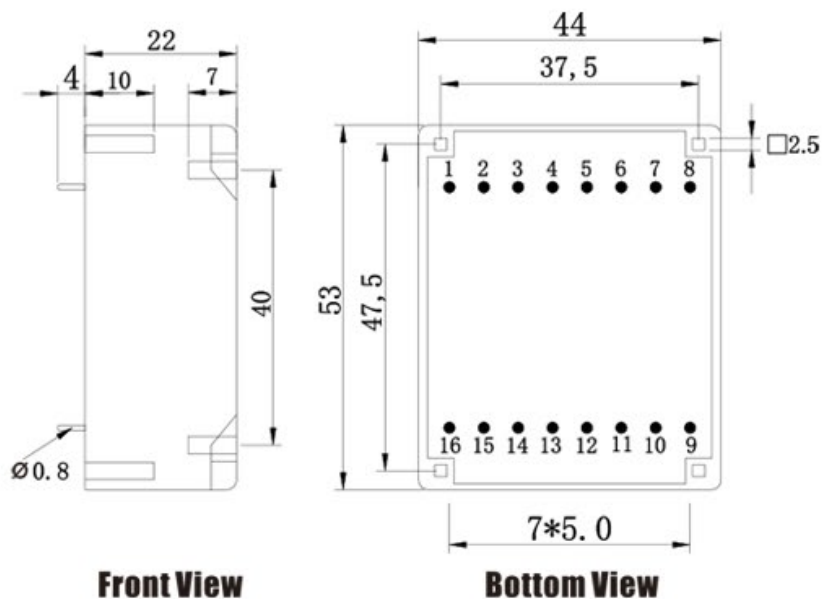

**Schematics**

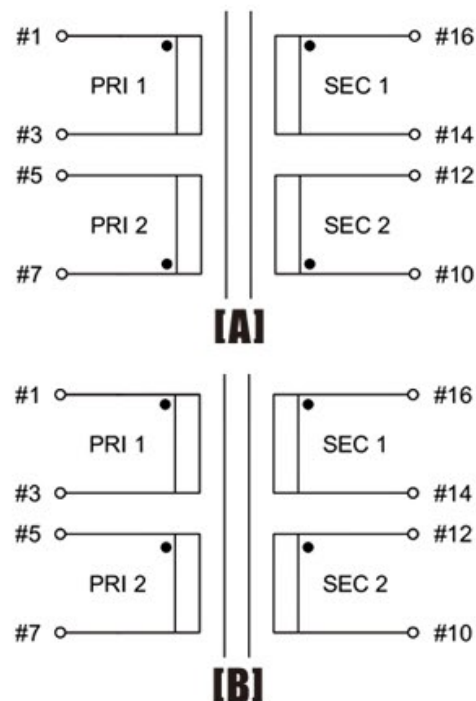

Tolerances : <10mm ±0.3mm  
10--50mm ±0.5mm  
Custom-made transformer also will be welcome.

