

Type **UI30/16.5**

Power **10.0 VA**

Weight **260g**

shipping unit per box: **18 pcs** temperature class: **ta 50°C/B**

Vacuum filled casting

Split bobbin design winding

Dielectric strength 3750Vrms

PART NO	Output ta 50°C/B	Prim.V	Connecting pins	Operating point sec. ± 10%	Connecting pins	No-load voltage V ± 10%
TG3016-U2-1000-090-D	10.0 W	115	1---3	9V 555.5mA	10---12	11.9V
		115	5---7	9V 555.5mA	14---16	11.9V

According to

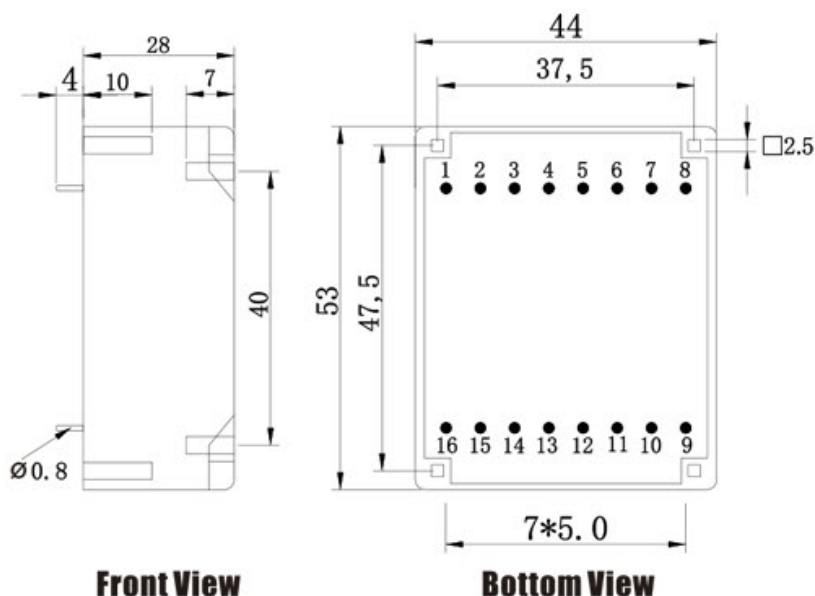

Schematics

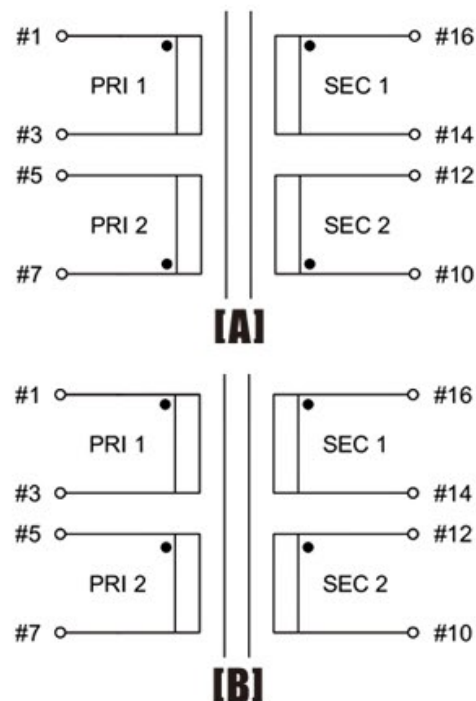

Tolerances : <10mm ±0.3mm
10--50mm ±0.5mm
Custom-made transformer also will be welcome.

