

Type **UI39/10.2**

Power **14.0 VA**

Weight **315g**

shipping unit per box: **12 pcs** temperature class: **ta 50°C/B**

Vacuum filled casting

Split bobbin design winding

Dielectric strength 3750Vrms

PART NO	Output ta 50°C/B	Prim.V	Connecting pins	Operating point sec. ± 10%	Connecting pins	No-load voltage V ± 10%
TG3910-U2-1400-090-D	14.0 W	115	1---4	9V 777.7mA	12---14	10.9V
		115	6---9	9V 777.7mA	17---19	10.9V

According to

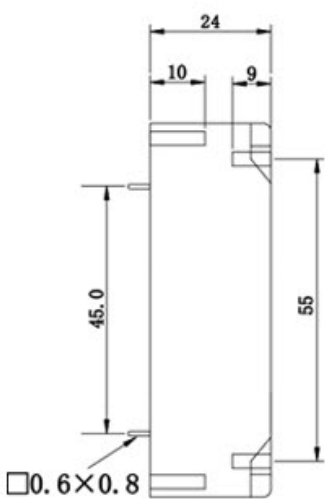

Front View

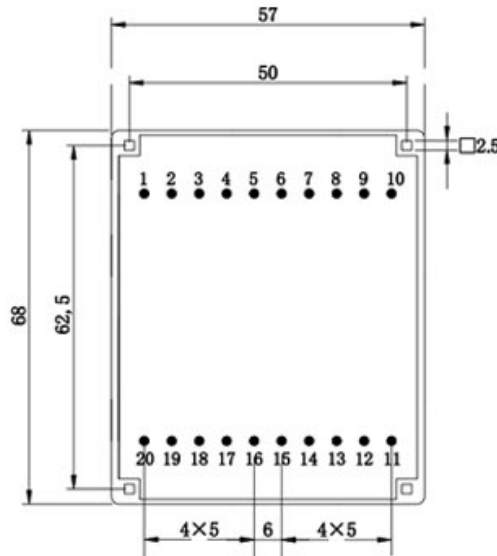

Bottom View

Tolerances : <10mm ±0.3mm
10--70mm ±0.5mm

Custom-made transformer also will be welcome.

Schematics

