

Type **UI39/13.5**

Power **18.0 VA**

Weight **385g**

shipping unit per box: **12 pcs** temperature class: **ta 50°C/B**

Vacuum filled casting

Split bobbin design winding

Dielectric strength 3750Vrms

PART NO	Output ta 50°C/B	Prim.V	Connecting pins	Operating point sec. ± 10%	Connecting pins	No-load voltage V ± 10%
TG3913-U2-1800-240-D	18.0 W	115	1---4	24V 375.0mA	12---14	29.4V
		115	6---9	24V 375.0mA	17---19	29.4V

According to

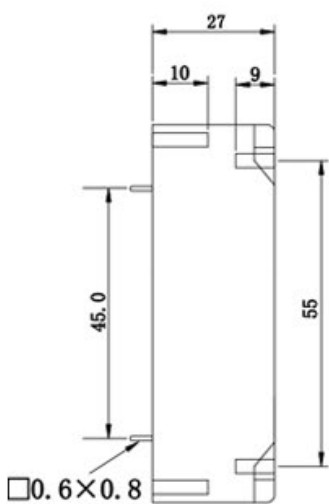

Front View

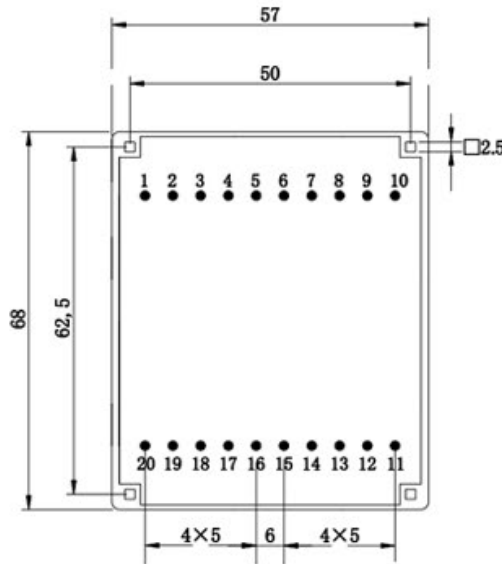

Bottom View

Tolerances : <10mm ±0.3mm
10--70mm ±0.5mm

Custom-made transformer also will be welcome.

Schematics

