

Type **UI39/21**

Power **30.0 VA**

Weight **530g**

shipping unit per box: **12 pcs** temperature class: **ta 50°C/B**

Vacuum filled casting

Split bobbin design winding

Dielectric strength 3750Vrms

PART NO	Output ta 50°C/B	Prim.V	Connecting pins	Operating point sec. ± 10%	Connecting pins	No-load voltage V ± 10%
TG3921-U2-3000-150-D	30.0 W	115	1---4	15V 1000.0mA	12---14	16.8V
		115	6---9	15V 1000.0mA	17---19	16.8V

According to

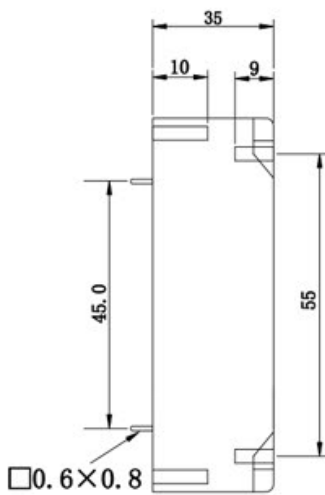

Front View

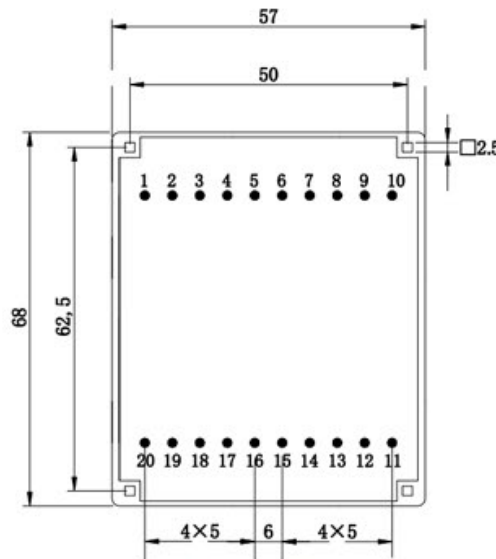

Bottom View

Tolerances : <10mm ±0.3mm
10--70mm ±0.5mm

Custom-made transformer also will be welcome.

Schematics

