

Type **UI39/21**

Power **30.0 VA**

Weight **530g**

shipping unit per box: **12 pcs**      temperature class: **ta 50°C/B**

**Vacuum filled casting**

Split bobbin design winding

**Dielectric strength 3750Vrms**

PART NO	Output ta 50°C/B	Prim.V	Connecting pins	Operating point sec. ± 10%	Connecting pins	No-load voltage V ± 10%
TG3921-U2-3000-180-D	30.0 W	115	1---4	18V 833.3mA	12---14	20.2V
		115	6---9	18V 833.3mA	17---19	20.2V

According to

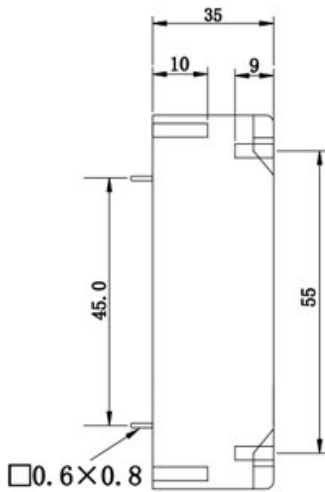

**Front View**

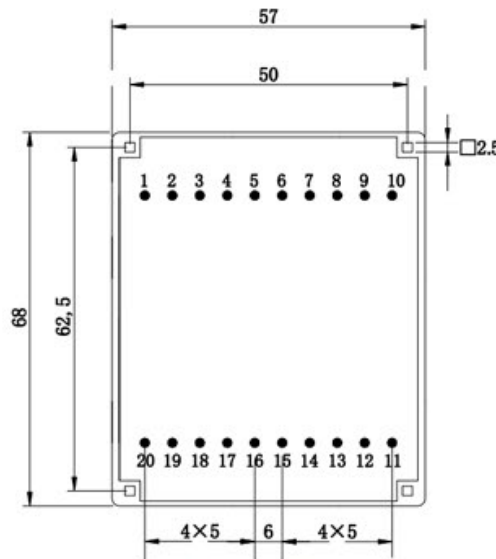

**Bottom View**

Tolerances : <10mm ±0.3mm  
10--70mm ±0.5mm

Custom-made transformer also will be welcome.

**Schematics**

